

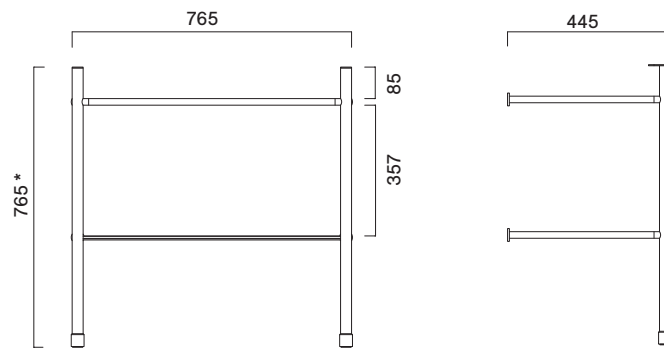

Frame D30 - 80x47

Description	cm 77x45 h77 kg 10,2	Structure Ø30 in chromed brass with extraclear tempered glass shelf back-painted white.
Codes, colours and finishes	04 5880 0061	Chrome <input type="radio"/>

Dimensions



* Height with end cap adjusted at halfway

